

Kurze Wörter schreiben

o
r
t
B

□ □ □ □

e
d
l
a
N

□ □ □ □

U
u
h

□ □ □

a
g
l
e
N

□ □ □ □

g
a
R
l
e

□ □ □ □

Eu
e
l

□ □ □

Zweisilbige Wörter schreiben

Ap
fel

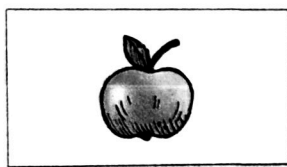

Apfel

ne
Bir

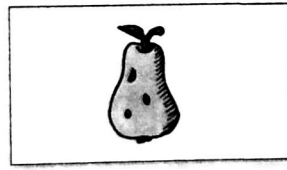



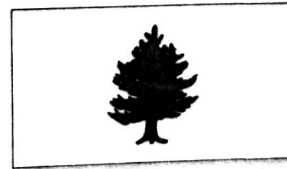

ne
Tan





tus
Kak





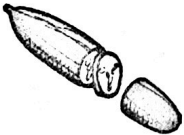

Zweisilbige Wörter schreiben

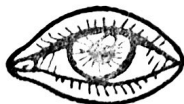
ze	Kat	
ter	Pu	
Del	fin	
schel	Mu	





Zweisilbige Wörter schreiben

te	Rat	
ke	Gur	
Erb	sen	
ge	Au	

Dreisilbige Wörter schreiben

nas A na	
ne lo Me	
tro ne Zi	
Erd bee re	

Dreisilbige Wörter schreiben

ne Ba na	
bee re Him	
ben kol Mais	
pferd See chen	

Kurze Wörter schreiben

e t
z l

u h
K

Sch
h u

ss T
a e

F t
o o

z l
P i

Kurze Wörter schreiben

z H
e r

t o
Au

F e
a k l

l G e
a b

z h
n a

a l m
e P

Dreisilbige Wörter schreiben

Tri gel
an

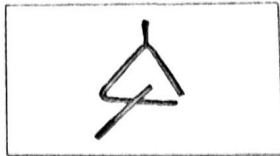

kan li
Pe



te
Trom pe



gu Pin
in



22

© sternchenverlag GmbH

Dreisilbige Wörter schreiben

Mo
rad tor

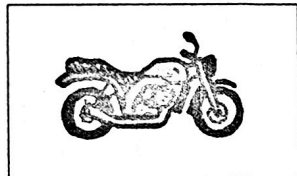

tar Gi
re

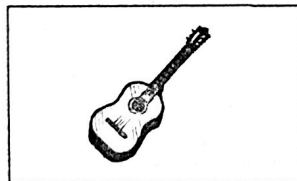

Pan
bär da



he Hand
schu

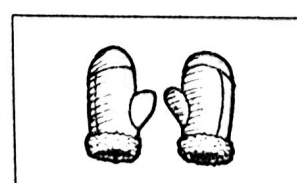

© sternchenverlag GmbH

23

Dreisilbige Wörter schreiben

Eich
chen hörn



pa gei
Pa



schwein
chen Meer

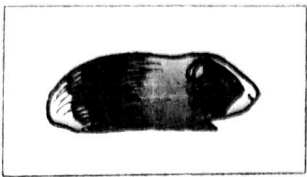

To ma
te

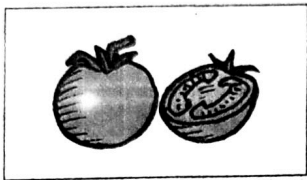

Dreisilbige Wörter schreiben

fel
tof Kar



men kohl
Blu



Pa
ka pri



Ra dies
chen

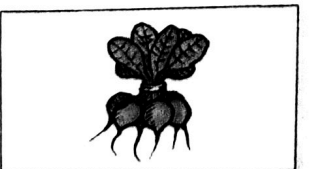

Kurze Wörter schreiben

ll
a B

--	--	--	--

o
d M
n

--	--	--	--

o e
n f

--	--	--	--

A e
ff

--	--	--	--

e
l A
r d

--	--	--	--

a p
m L e

--	--	--	--

Kurze Wörter schreiben

l e
A s
m

--	--	--	--

S
nn e
o

--	--	--	--

sch i
F

--	--	--	--

e i
r n
B

--	--	--	--

B ie
n e

--	--	--	--

r B
u g

--	--	--	--

Lautgetreue Wörter schreiben

au H s



i H a

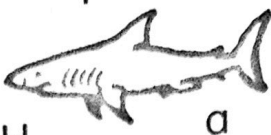

l o a C

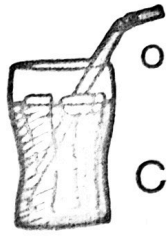

a O p



B u t l

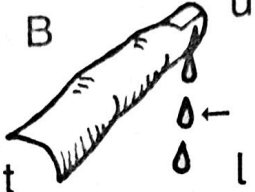

a l m e K



Lautgetreue Wörter schreiben

K u n a

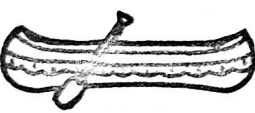

s M au



H u t

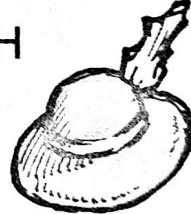

i D o n

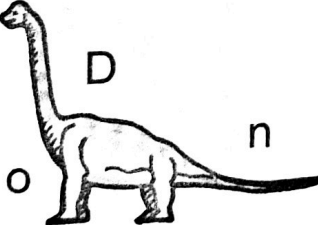

A t s

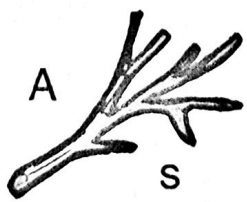

w i K i



Kurze Wörter schreiben

e s
a N

--	--	--	--

m N
e a

--	--	--	--

e s
a H

--	--	--	--

e M
ö w

--	--	--	--

H o
e s

--	--	--	--

R e
o s

--	--	--	--

Kurze Wörter schreiben

e L
p u

--	--	--	--

n e
E t

--	--	--	--

E e
l s

--	--	--	--

tt l
a B

--	--	--	--

B e
u m l

--	--	--	--

o s
e D

--	--	--	--

Lautgetreue Wörter schreiben

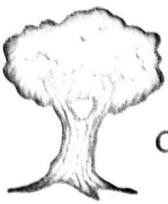
m
B au

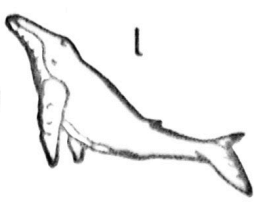
B a u m

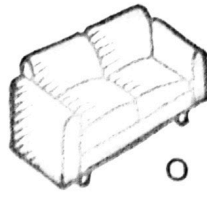
a l
W

[] [] []

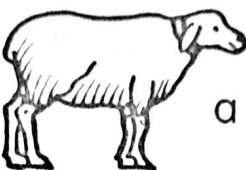
S
a o f

[] [] []

t r
P a
i

[] [] [] []

Sch
f a

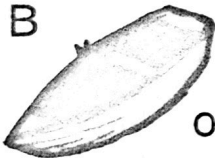
[] [] []

f U
o

[] [] []

Lautgetreue Wörter schreiben

B
t oo

[] [] []

S
a l
t a

[] [] [] []

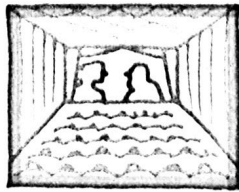
a Sch
l

[] [] []

O
m a

[] [] []

n o
i K

[] [] [] []

m
a
L a

[] [] [] []